



Parametric assessment of the Activated Corrosion Products on the ITER Water Cooled Lithium Lead Test Blanket System

Alberto Previti, Giovanni Mariano

Contributors



Alberto Previti^{a,*}, Giovanni Mariano^{a,e}, Andrea Colangeli^a, Frédéric Dacquait^b, Salvatore D'Amico^c, Francesca Fantini^d, Davide Flammini^a, Nicola Fonnesu^a, Fabio Moro^a, Simone Noce^a, Nicholas Terranova^a, Rosaria Villari^a, Paul Wouters^d

^aENEA, FSN Department, Via Enrico Fermi 45, 00044 Frascati, Rome, Italy

^bCEA, DES, IRESNE, DTN, Cadarache, Saint-Paul Lez Durance, F-13108, France

^cEUROfusion - Programme Management Unit, Boltzmannstrasse 2, 85748 Garching, Germany

^dFusion for Energy (F4E) Josep Pla 2, Torres Diagonal Litoral B3, 08019 Barcelona, Spain

^eITER Organization, Route de Vinon sur Verdon, Saint Paul Lez Durance, France

*corresponding author: alberto.previti@enea.it



Several phenomena take place in the water cooling system in a tokamak:

- materials under neutron flux undergo activation
- metals not in vacuum are subject to corrosion

Corrosion results in products and are released in the coolant, thus transported and deposited along the circuit.

Control of corrosion is of paramount importance in nuclear reactor → realized via coolant chemical parameters (e.g. pH, redox)

Corrosion products may be activated because of the neutron irradiation.

- controllable problem from a **technological point of view** (i.e. water chemistry).
- challenging issue from the **safety point of view** (i.e. activation)
 - radioprotection: impact on Occupational Radiation Exposure (ORE) for maintenance activities
 - environment: minimization of release/waste, radioactive source in case of accident/incident
 - availability: optimization of reactor operation

ACP phenomenology



ACP assessment involves several phenomena:

- corrosion-release
- dissolution
- precipitation
- erosion
- deposition
- advection
- purification
- activation
- radioactive decay

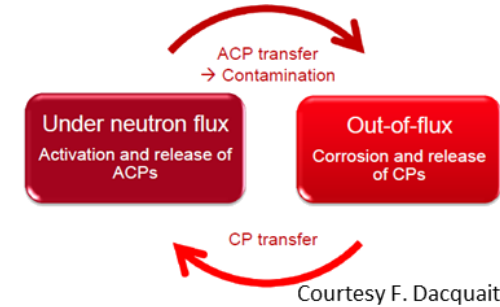

Courtesy F. Dacquit

multiphysics
problem

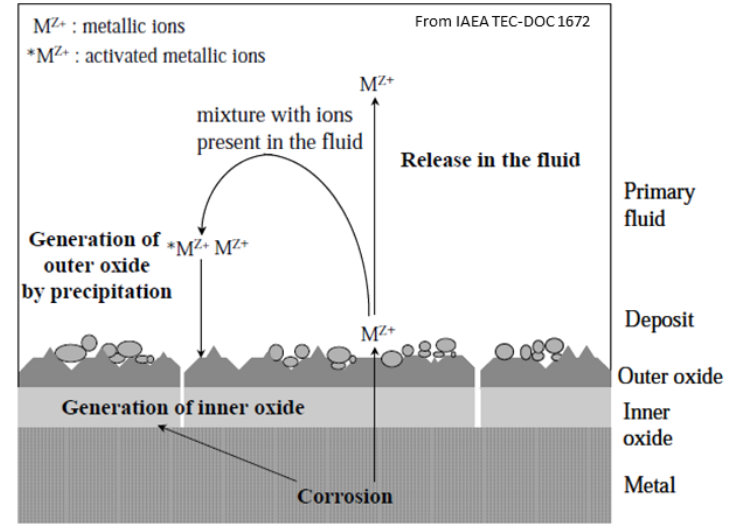

Collective dose for operation and maintenance of PWRs

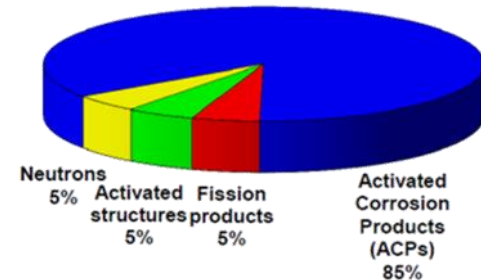

Corrosion products generates gamma radiation fields
→ dose to workers

Current experience comes mostly from nuclear fission power stations (e.g. PWR)

OSCAR-Fusion code



Outil de **S**imulation de la **C**ontAmination en **R**éacteur: developed by CEA, reference tool for EUROfusion Safety and Environment Work Package and for ITER-IO Nuclear Safety

- Simulation of contamination in nuclear reactor systems during operation and shutdown
- Determination of masses/activities of CPs/ACPs/FPs/actinides in solid/liquid/gaseous phases in circuits
- Originally developed for PWR in collaboration with EDF and Framatome → modified version OSCAR-Fusion for ITER/fusion applications
- **Cooling system discretized in control volumes (0D system simulation approach)**
- 6 media: base metal, inner oxide, deposit/outer oxide, particles, ions and filters/resins
- **Validation on PWR operational experience**
- **Considered elements:**
 - **Ni, Co, Fe, Cr, Cu, Mn, Ag, Sb, Zn, Zr**

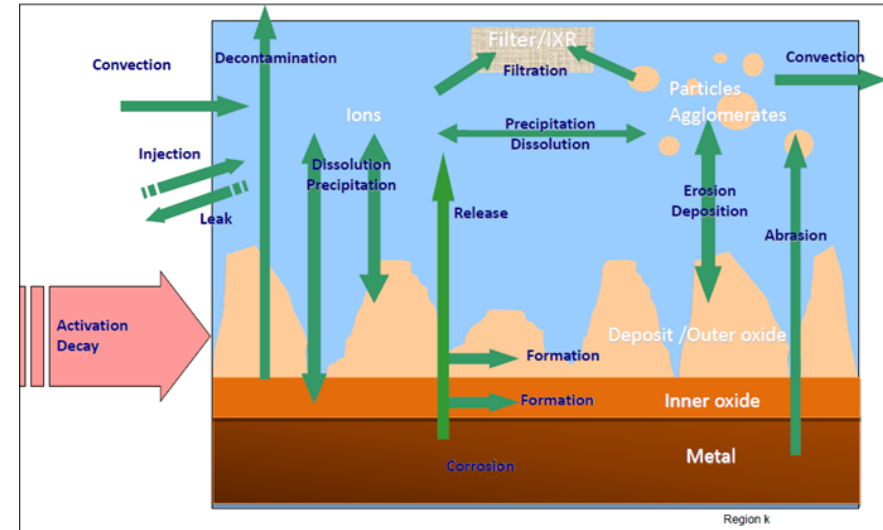

WCLL description



WCLL: one of the Test Breeding Modules to be tested at ITER

- PbLi⁶ to produce tritium
- water cooled
 - very long circuit
 - **ACP assessment required**

Cooling involves intermediate systems up to the Component Cooling Water System (CCWS)

- water cooling system (WCS)
- coolant purification system (CPS)

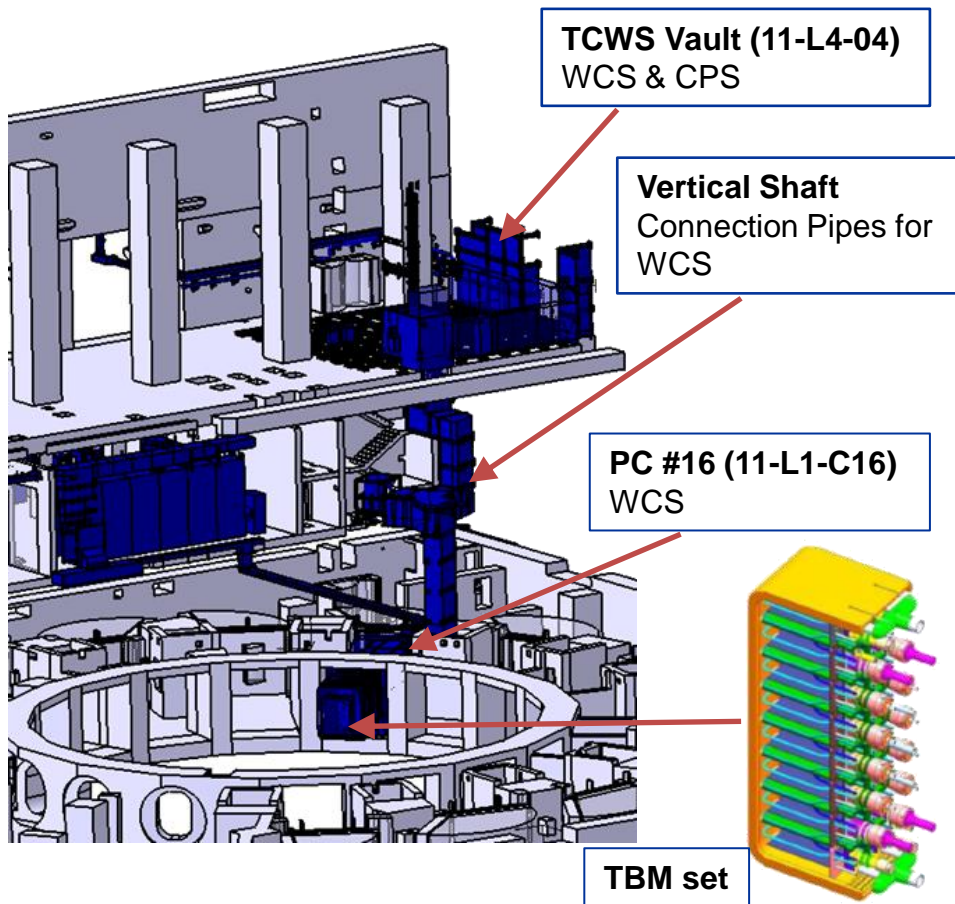
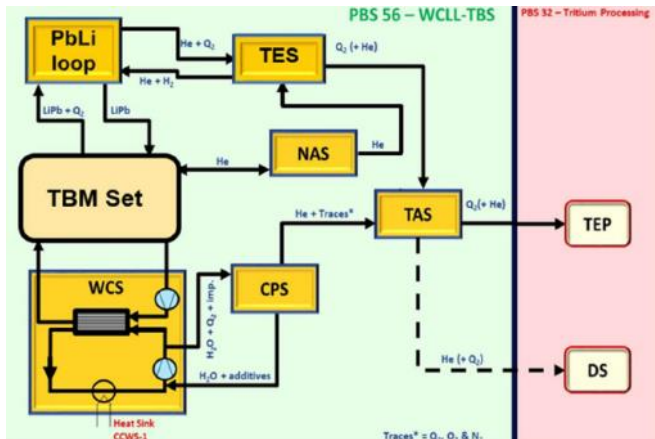

Input data summary



Geometric and thermal hydraulics (from CAD and system simulations)

- wet surface [m²]
- equivalent hydraulic diameter [m]
- coolant velocity [m/s]
- coolant and wall temperature [°C]
- efficiency of filter & resin [-]
- mass flow rate distribution

Corrosion and Oxide Data

- corrosion data for SS316L and EUROFER97
- initial thickness of inner and deposit/outer oxide layers

Material Properties

- chemical composition [% weight]
- roughness [μm]
- tortuosity [-]
- density [g/cm³]

Operation mode

- duration of periods [d]
- water chemistry data:
 - [H₂] conc. [cm³/kg_w]
 - [B] conc. [ppm]
 - [O₂] conc. [ppm]
 - [Li] conc. [ppm]
- fraction [-] of the nominal power during the period
- off operation time after the period [d]

Neutron activation

- decay data
- activation reaction rates
- space scaling factors

WCS+CPS nodalization



- Analysis of P&ID → nodalization in regions with assigned conditions
 - first loop of WCS (i.e. where activated water flows)
 - whole CPS
- Each region has a given temperature → subdivisions to represent gradients
- Geometric data retrieved from thermo-hydraulic system simulations

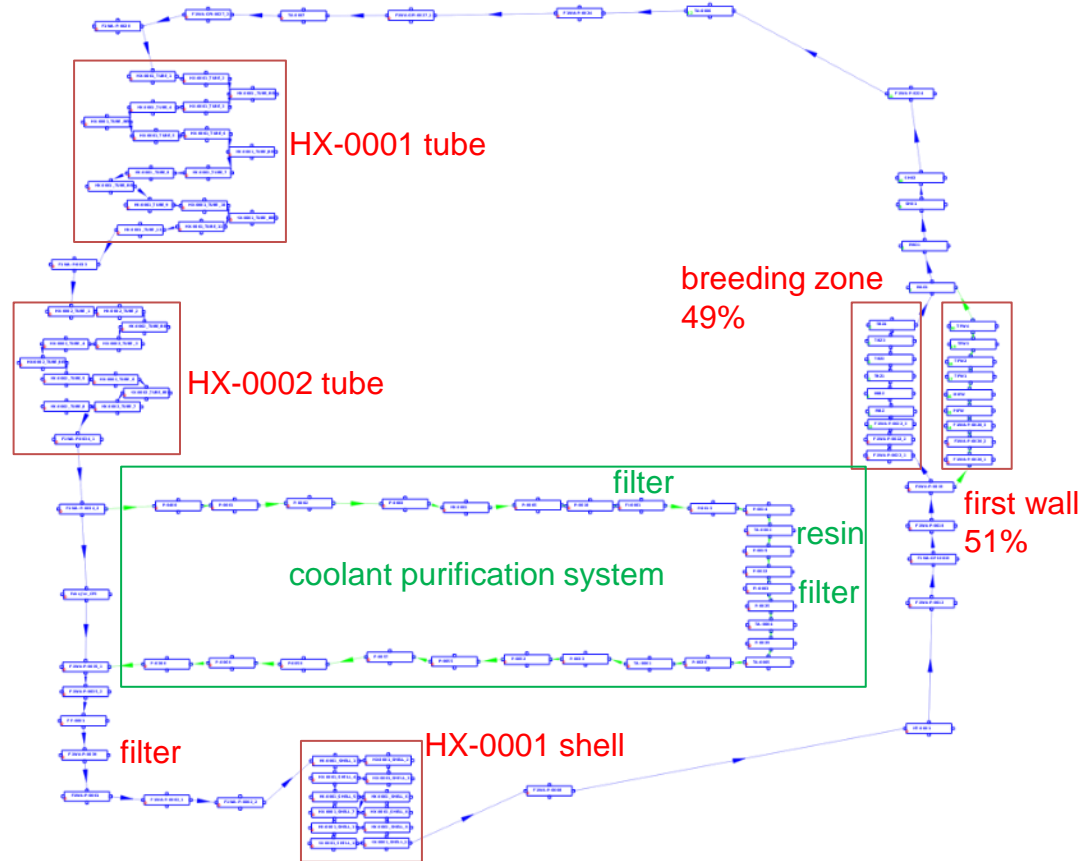

Operational scenario



Plasma scenario based on

- ITER operational shifts as defined
- neutron budget of current baseline (5×10^{26} per campaign)
- SA-2 + back-to-back pulses at the end of each campaign
- 2 campaigns, with replacement of filters, resins, and cooling water

Scenario adapted for OSCAR

- power/temperature cycles to account for differences in corrosion rates:
 - NOS: 295-328 °C TBM inlet-outlet
 - HSOS: 295 °C uniform
- Reaction rates computed via MCNP and activation of base metal determined by comparison with FISPACT-II

	Duration	Fusion Power (MW)	Repetition	Neutron yield	Fluid state*
Campaign FPO-7	1.325 y	33.7	1	5×10^{26} n	NOS/HSOS
	1350 s	0	48 x 6 times		HSOS
	450 s	500			NOS
	0.672 y	0	1		
LTM	Replacement of filters and resins in CPS / Fresh water				
Campaign FPO-8	1.325 y	33.7	1	5×10^{26} n	NOS/HSOS
	1350 s	0	48 x 6 times		HSOS
	450 s	500			NOS
	1350 s	0	3 times		HSOS
	450 s	700			NOS
	Shutdown				

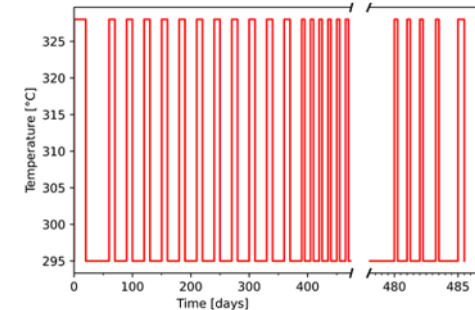
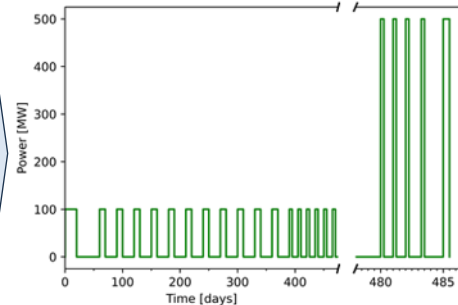

Input parameters



Number of regions: 113

Wet Surfaces

- EUROFER97 (TBM set): 8.8 m²
- Inconel 625 (heat exchangers tube side): 96 m²
- AISI SS316L (rest of the circuit): 91 m²

Pipe roughness: 12 μm

Initial deposit thickness: 6 μm
(i.e. ½ roughness)

Conditions

- Mass Flow Rate: 3.74 kg/s
- TBM T_{max} – T_{min}: 328 °C – 295 °C
- CPS Temp: 50 °C
- Hydrogen Addition: 10 cm³ (STP)/kg
- LiOH: 0.5 mg/kg_w
- pH (300°C): 6.73

LiOH instead of KOH, since OSCAR supports only LiOH, keeping same pH

Corrosion Rates [g/s/m²] – Moorea law

- EUROFER97
 - STCR: 1.6e-05
 - LTCR: 4.6e-06
- Inconel 625
 - STCR: 1.6e-06
 - LTCR: 4.6e-07
- AISI SS316L
 - STCR: 1.6e-06
 - LTCR: 4.6e-07

SS316/Inconel625 → data from PWR experience

EUROFER97 → stainless steel designed for reduced activation, but having worse corrosion properties: 10x values considered

Inner oxide activities (whole circuit)

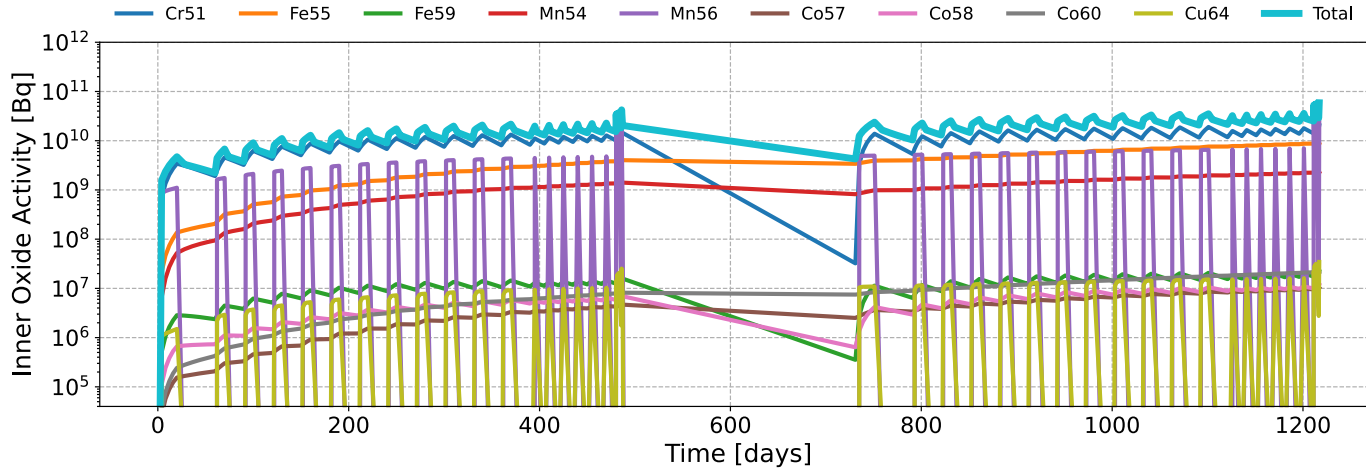

- inner oxide activity dominated by Cr-51 and Mn-56 (at shutdown)
- mass of the inner oxide at the end: 130 g

Nuclide	Shutdown [Bq]	12 days [Bq]
Co57	1.03E+07	9.97E+06
Co58	1.18E+07	1.05E+07
Co60	2.16E+07	2.15E+07
Cr51	2.06E+10	1.54E+10
Cu64	3.45E+07	9.00E+00
Fe55	8.97E+09	8.89E+09
Fe59	2.23E+07	1.86E+07
Mn54	2.31E+09	2.25E+09
Mn56	2.70E+10	0.00E+00
Total	5.89E+10	2.66E+10

Deposit/outer oxide activities (whole circuit)

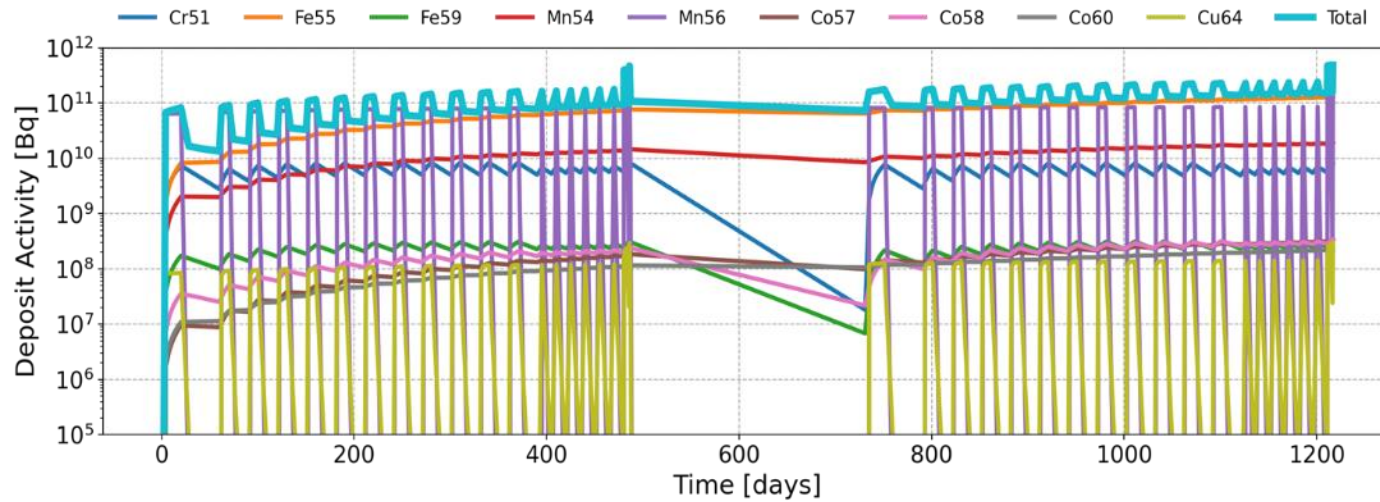

- during the pulses: activity dominated by Mn-56
- between the pulses: activity dominated by Fe-55

Nuclide	Shutdown [Bq]	12 days [Bq]
Co57	2.80E+08	2.72E+08
Co58	3.06E+08	2.74E+08
Co60	2.74E+08	2.73E+08
Cr51	9.89E+09	7.40E+09
Cu64	5.71E+08	1.49E+02
Fe55	1.74E+11	1.73E+11
Fe59	4.51E+08	3.76E+08
Mn54	3.33E+10	3.24E+10
Mn56	5.03E+11	0.00E+00
Total	7.22E+11	2.14E+11

Coolant activity (whole circuit)

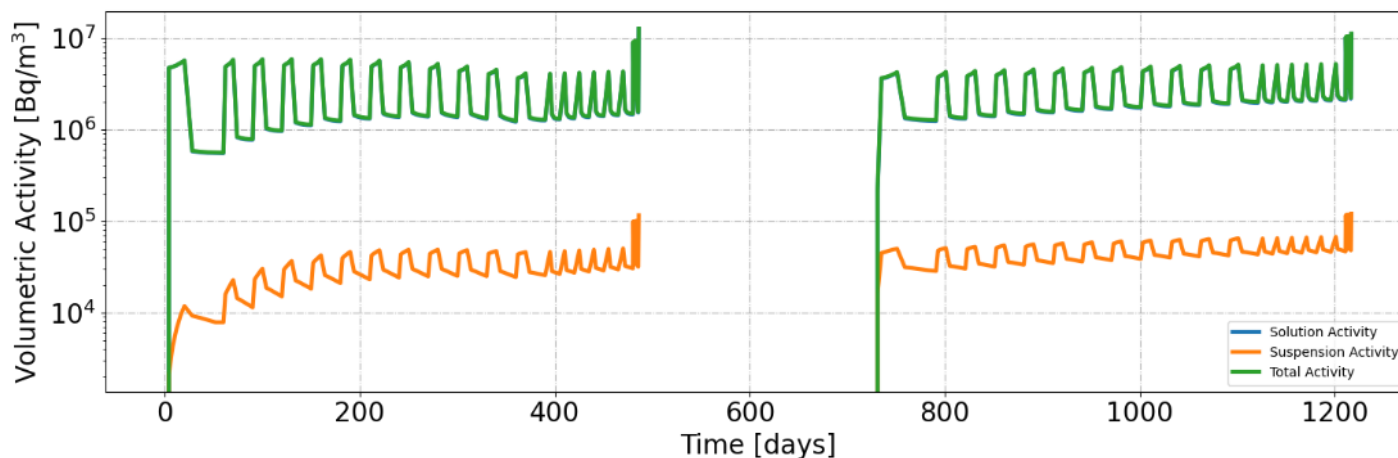

- Coolant activity dominated by ion solution
- Dominated by Fe-55 and Mn-54

Nuclide	Shutdown [Bq]	12 days [Bq]
Co57	3.31E+02	3.21E+02
Co58	4.43E+02	3.96E+02
Co60	8.45E+02	8.41E+02
Cr51	1.17E+04	8.72E+03
Cu64	2.79E+04	7.29E-03
Fe55	2.79E+06	2.76E+06
Fe59	7.37E+03	6.16E+03
Mn54	3.48E+06	3.39E+06
Mn56	3.77E+07	0.00E+00
Total	4.40E+07	6.17E+06

Filters and resins activities



Filter FF-0001 (WCS – NO Replacement)

Nuclide	END of 1° Campaign		END of 2° Campaign	
	Activity [Bq]	Percentage	Activity [Bq]	Percentage
Co57	3.99E+06	0.07%	9.65E+06	0.08%
Co58	2.93E+06	0.05%	4.30E+06	0.04%
Co60	4.94E+06	0.08%	1.31E+07	0.11%
Cr51	6.06E+07	1.01%	5.68E+07	0.49%
Cu64	3.32E+04	0.00%	4.34E+04	0.00%
Fe55	5.26E+09	87.61%	1.03E+10	89.56%
Fe59	4.67E+06	0.08%	4.67E+06	0.04%
Mn54	6.56E+08	10.93%	1.10E+09	9.58%
Mn56	1.05E+07	0.17%	9.52E+06	0.08%

Filter FI-0001 (CPS)

Nuclide	END of 1° Campaign		END of 2° Campaign	
	Activity [Bq]	Percentage	Activity [Bq]	Percentage
Co57	1.09E+05	0.07%	2.48E+05	0.11%
Co58	8.04E+04	0.05%	1.18E+05	0.05%
Co60	1.35E+05	0.08%	2.55E+05	0.11%
Cr51	1.66E+06	1.01%	1.56E+06	0.69%
Cu64	1.35E+03	0.00%	1.67E+03	0.00%
Fe55	1.44E+08	87.60%	1.96E+08	87.00%
Fe59	1.28E+05	0.08%	1.28E+05	0.06%
Mn54	1.80E+07	10.94%	2.67E+07	11.86%
Mn56	2.86E+05	0.17%	2.60E+05	0.12%

Filter FI-0003 (CPS)

Nuclide	END of 1° Campaign		END of 2° Campaign	
	Activity [Bq]	Percentage	Activity [Bq]	Percentage
Co57	1.09E+03	0.07%	2.47E+03	0.11%
Co58	8.02E+02	0.05%	1.18E+03	0.05%
Co60	1.35E+03	0.08%	2.55E+03	0.11%
Cr51	1.70E+04	1.04%	1.60E+04	0.71%
Cu64	3.45E+02	0.02%	4.02E+02	0.02%
Fe55	1.44E+06	87.64%	1.96E+06	87.03%
Fe59	1.28E+03	0.08%	1.28E+03	0.06%
Mn54	1.80E+05	10.94%	2.67E+05	11.86%
Mn56	1.46E+03	0.09%	1.31E+03	0.06%

Resin TA-0002 (CPS)

Nuclide	END of 1° Campaign		END of 2° Campaign	
	Activity [Bq]	Percentage	Activity [Bq]	Percentage
Co57	7.61E+04	0.00%	6.98E+04	0.00%
Co58	5.89E+04	0.00%	4.79E+04	0.00%
Co60	3.96E+05	0.01%	5.41E+05	0.01%
Cr51	4.61E+05	0.01%	4.47E+05	0.01%
Cu64	4.61E+04	0.00%	5.09E+04	0.00%
Fe55	2.24E+09	41.61%	2.45E+09	41.92%
Fe59	1.75E+06	0.03%	1.67E+06	0.03%
Mn54	3.11E+09	57.87%	3.37E+09	57.68%
Mn56	2.50E+07	0.46%	2.05E+07	0.35%

Sensitivity study



Parameters selected for parametric study:

- pH
- hydrogen content
- pipe roughness
- corrosion rate

→ The idea is to assess the ACP inventories considering the uncertainties on these key parameters

→ Automatic processing required!

- pH: 6.3, 6.6, 6.9, 7.2, 7.5
 - LiOH concentration found to attain target pH
- hydrogen content: 10, 25 cm³/kg
 - to control radiolysis, with a reasonable maximum
- pipe roughness: 6, 12, 24 μm
 - based on metallurgical Ra definition (average deviation), considering different grades
- EUROFER97 corrosion: x8, x10
 - due to the lack of specific experimental data, it has been set a multiple of the SS316 value

OSCAR-Fusion processing (base)

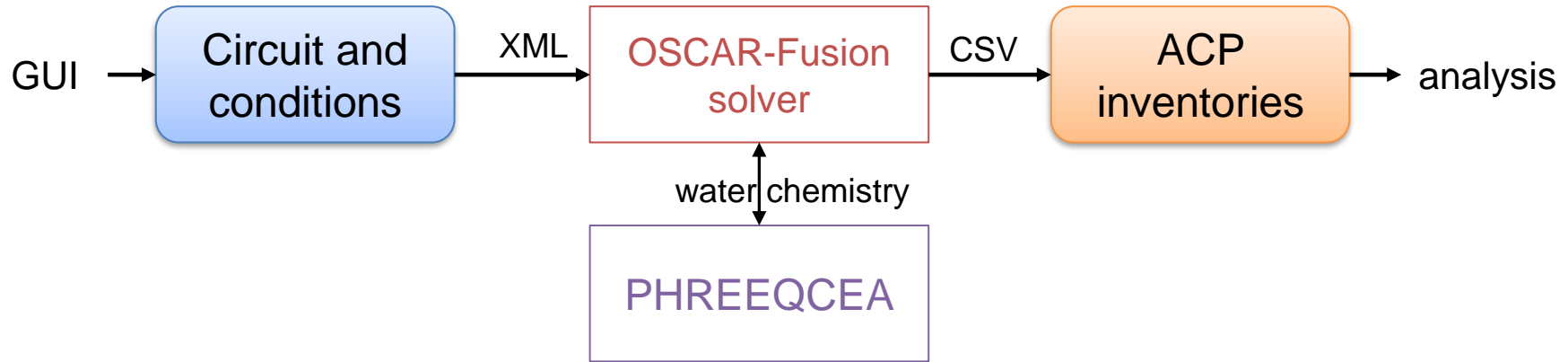

OSCAR-Fusion processing (enhanced)

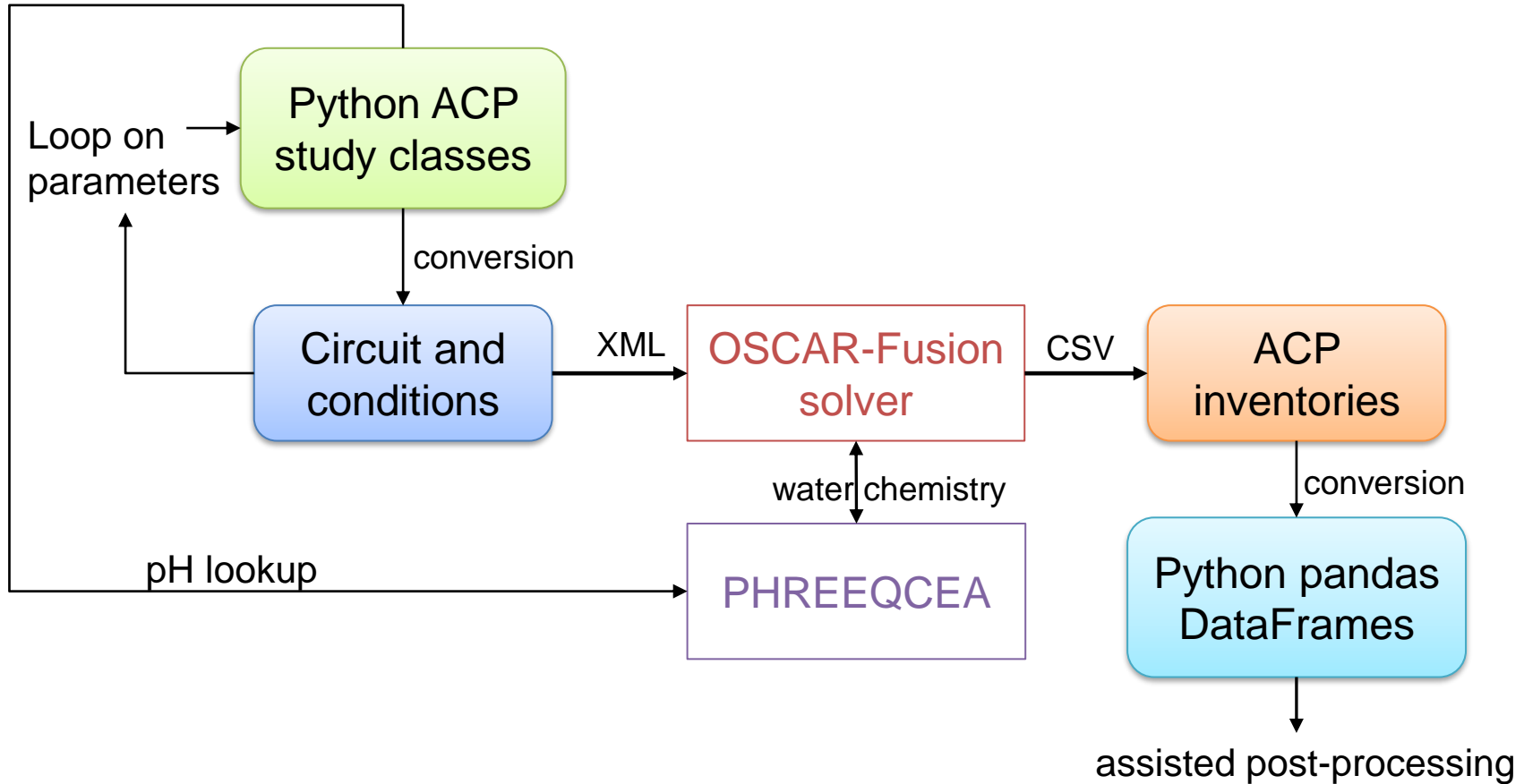

Parametric results ranges



- Relative difference with respect to reference case
{pH 6.73, rugosity 12 μm , H_2 10 cm^3/kg_w , EUROFER corrosion x10}

LiOH [ppm]	Li [ppm]	pH
0.188	0.051	6.3
0.372	0.107	6.6
0.8	0.217	6.9
1.55	0.442	7.2
3	0.898	7.5

OSCAR supports up to 1.5 ppm of Li

- Total values at shutdown considered: relative differences found (so far)
 - inner oxide [Bq] -24 % : +11 %
 - deposit / outer oxide [Bq] -39 % : +79 %
 - coolant ions [Bq/m^3] -24 % : +51 %
 - coolant particles [Bq/m^3] -18 % : +69 %

Parametric results (whole circuit, at shutdown)

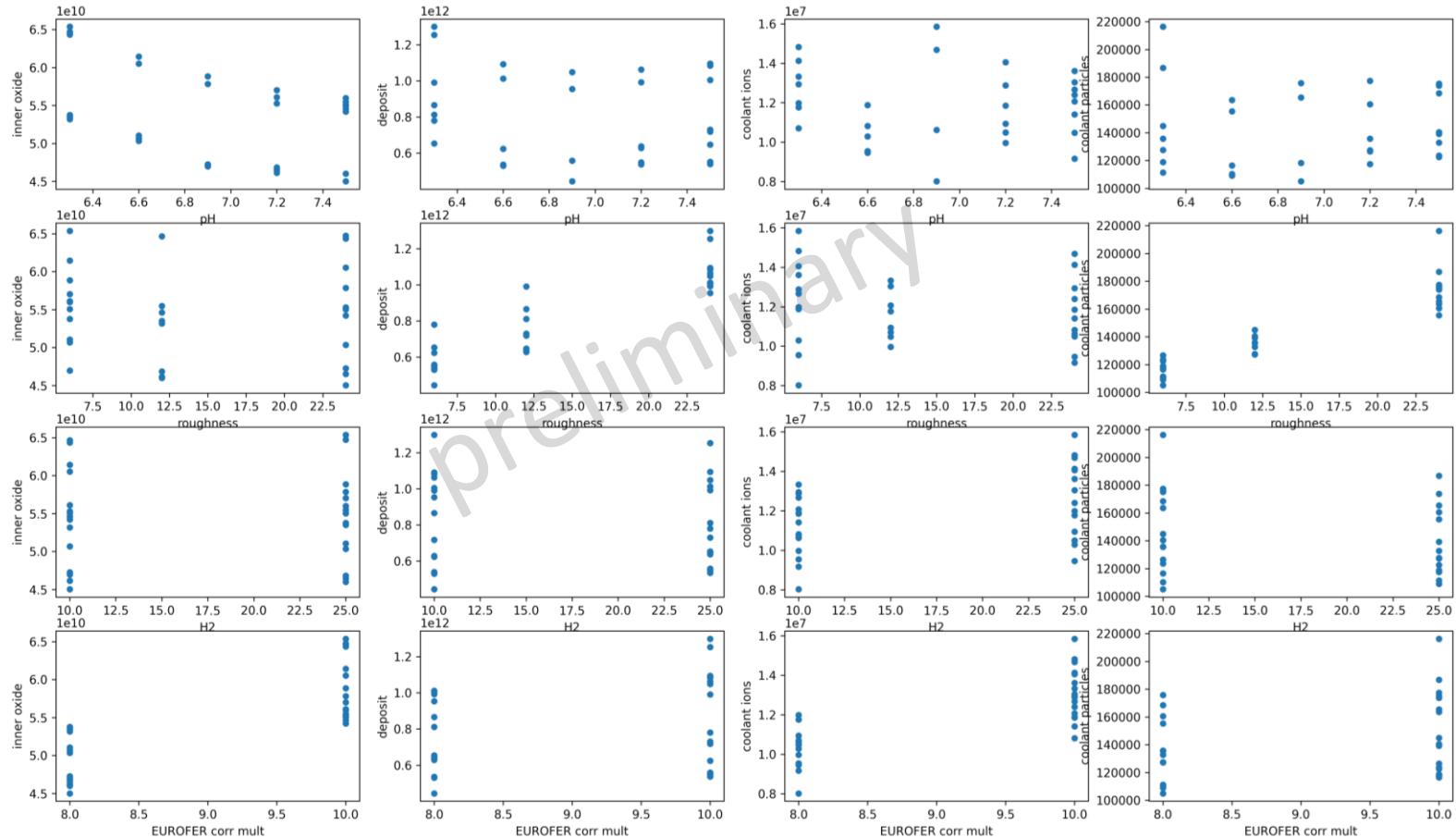

Parametric results (whole circuit, at shutdown)

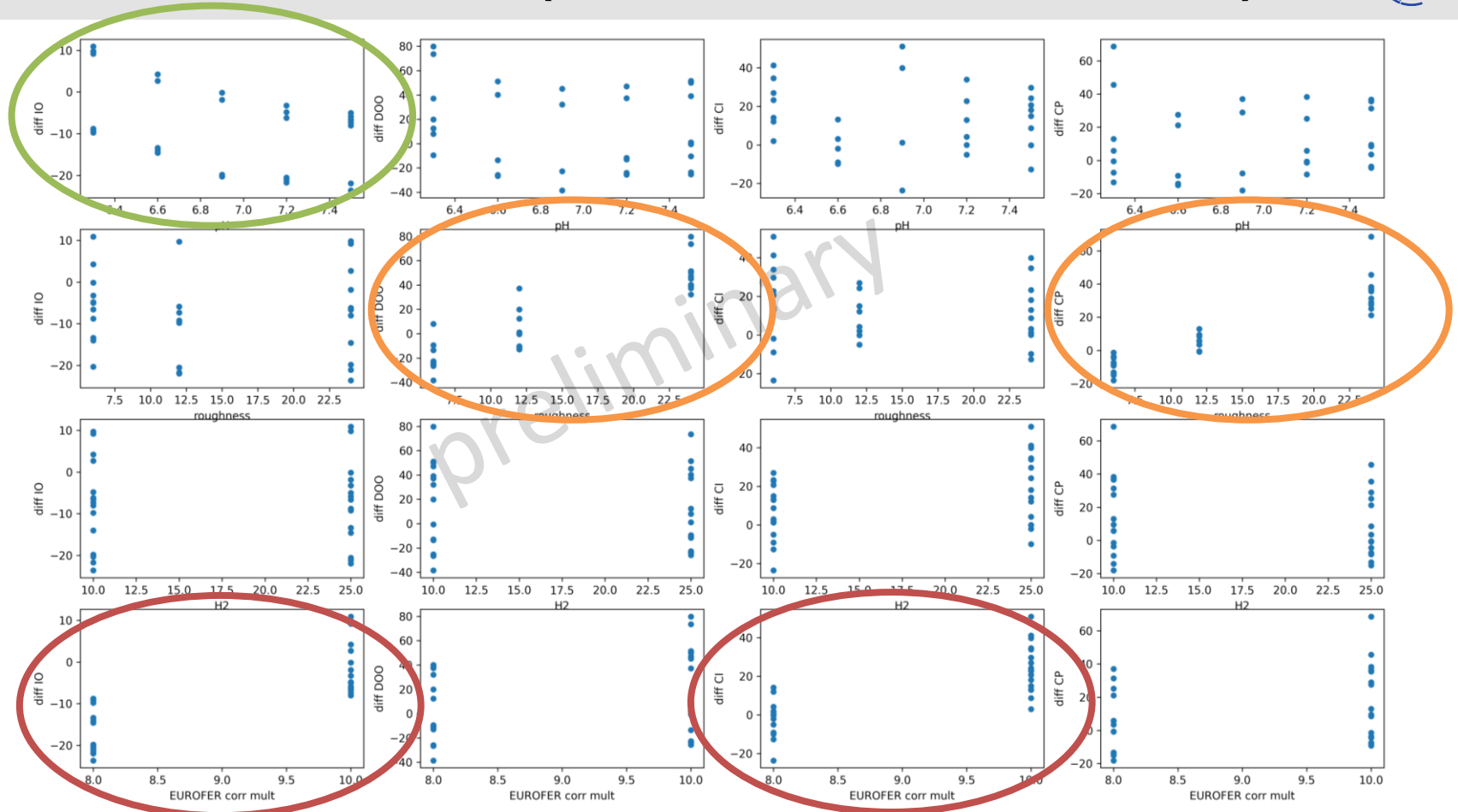

Parametric results tendencies: EUROFER97

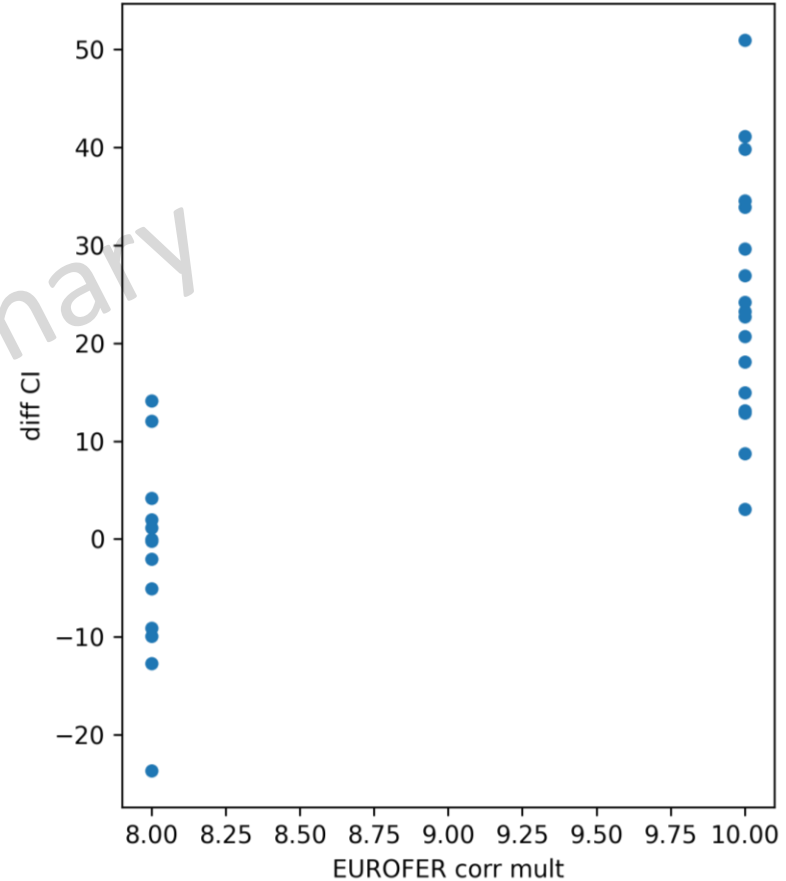
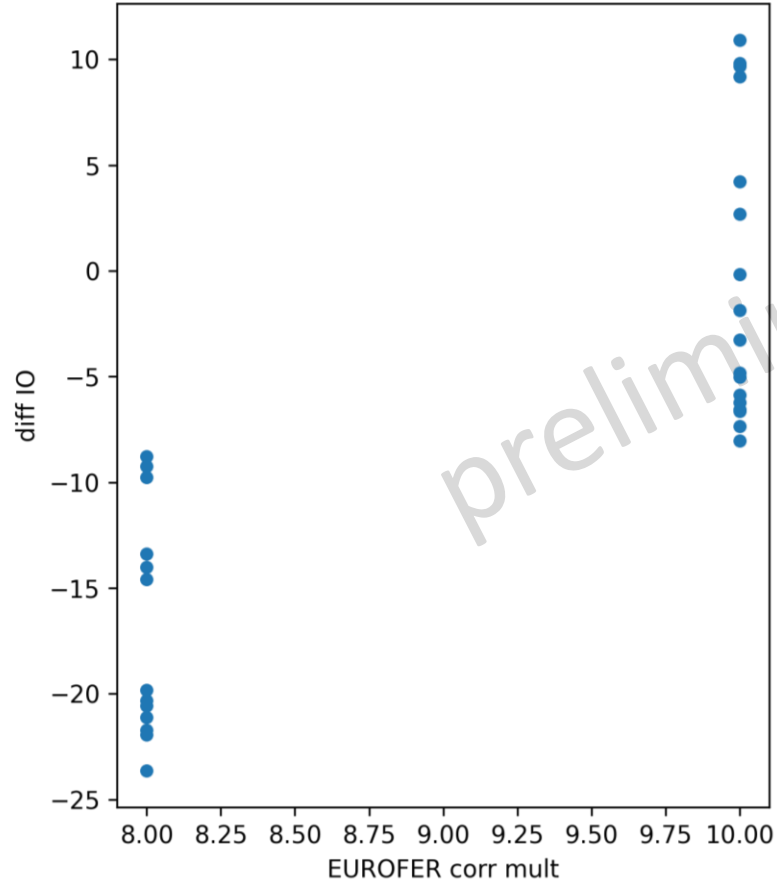

Parametric results tendencies: pH

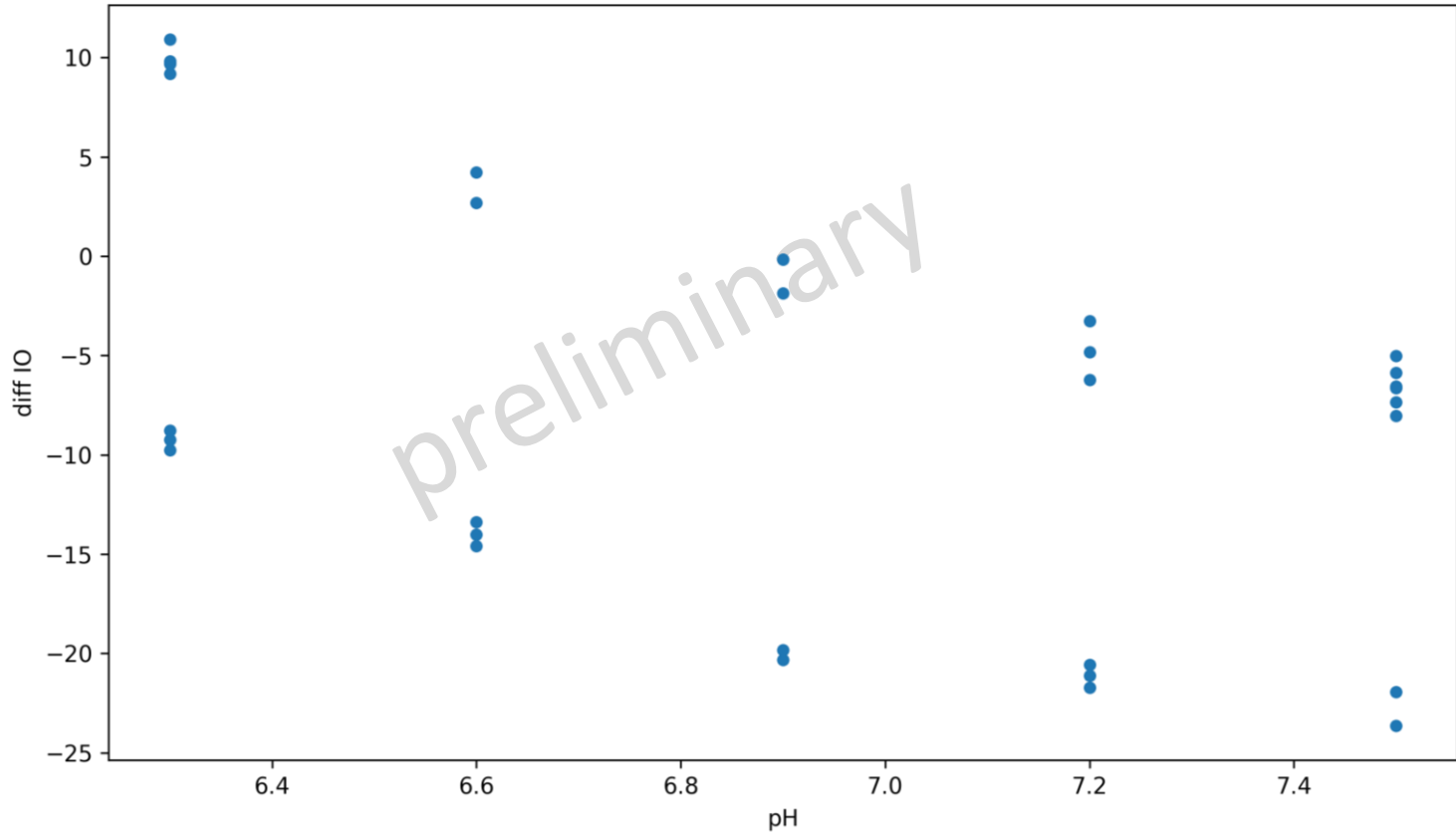

Parametric results tendencies: roughness

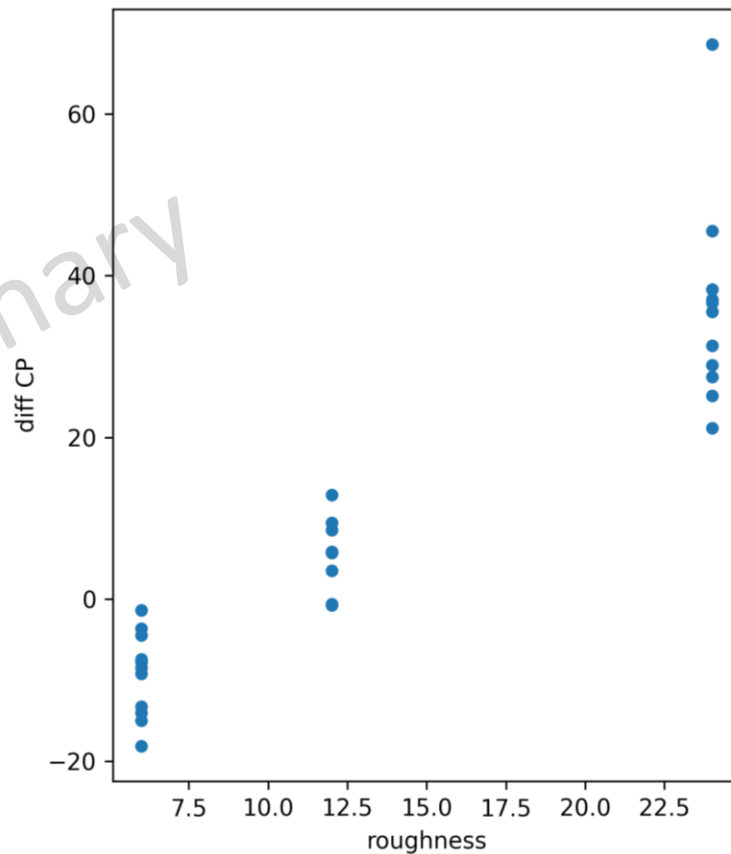
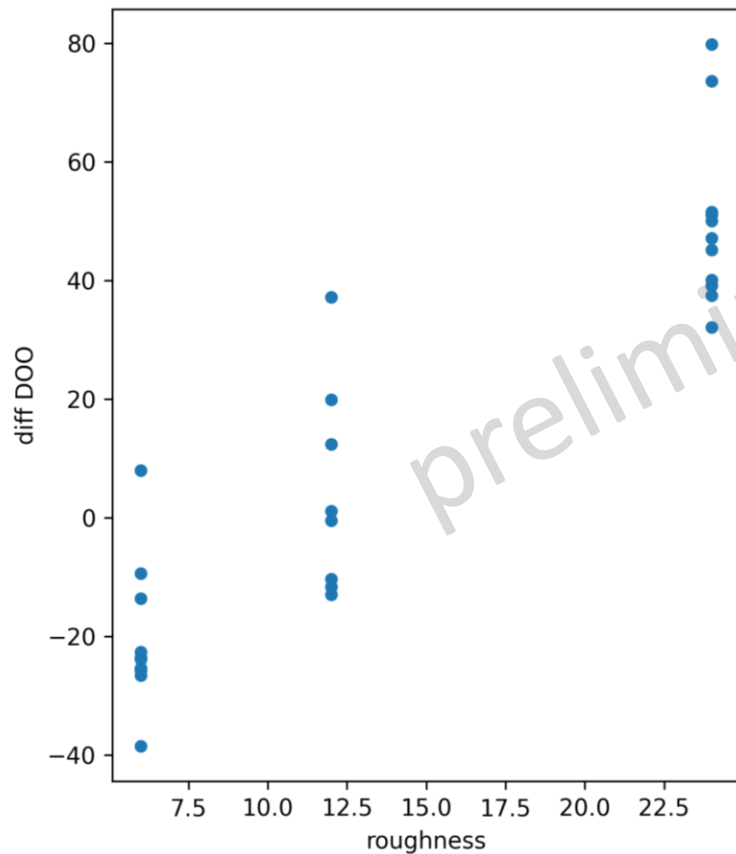

Conclusions



- Accurate ACP simulation of WCLL WCS+CPS established
 - based on models/correlations implemented in OSCAR-Fusion
- Pre-processing and post-processing toolset developed
 - ease to deal with parametric studies
- ACP activities at shutdown:
 - inner oxide dominated by Cr-51
 - deposit/outer oxide dominated by Fe-55
 - coolant dominated by Fe-55 and Mn-54
- Assessment of uncertainties on key parameters:
 - clear role of surface roughness identified/confirmed
 - EUROFER97 corrosion rate influences all parameters, but mostly inner oxide and coolant ions
 - less sensitive to H₂ addition
 - additional investigations are foreseen considering also initial deposit thickness



Thank you for your attention!

alberto.previti@enea.it